

Orion 44 4x5

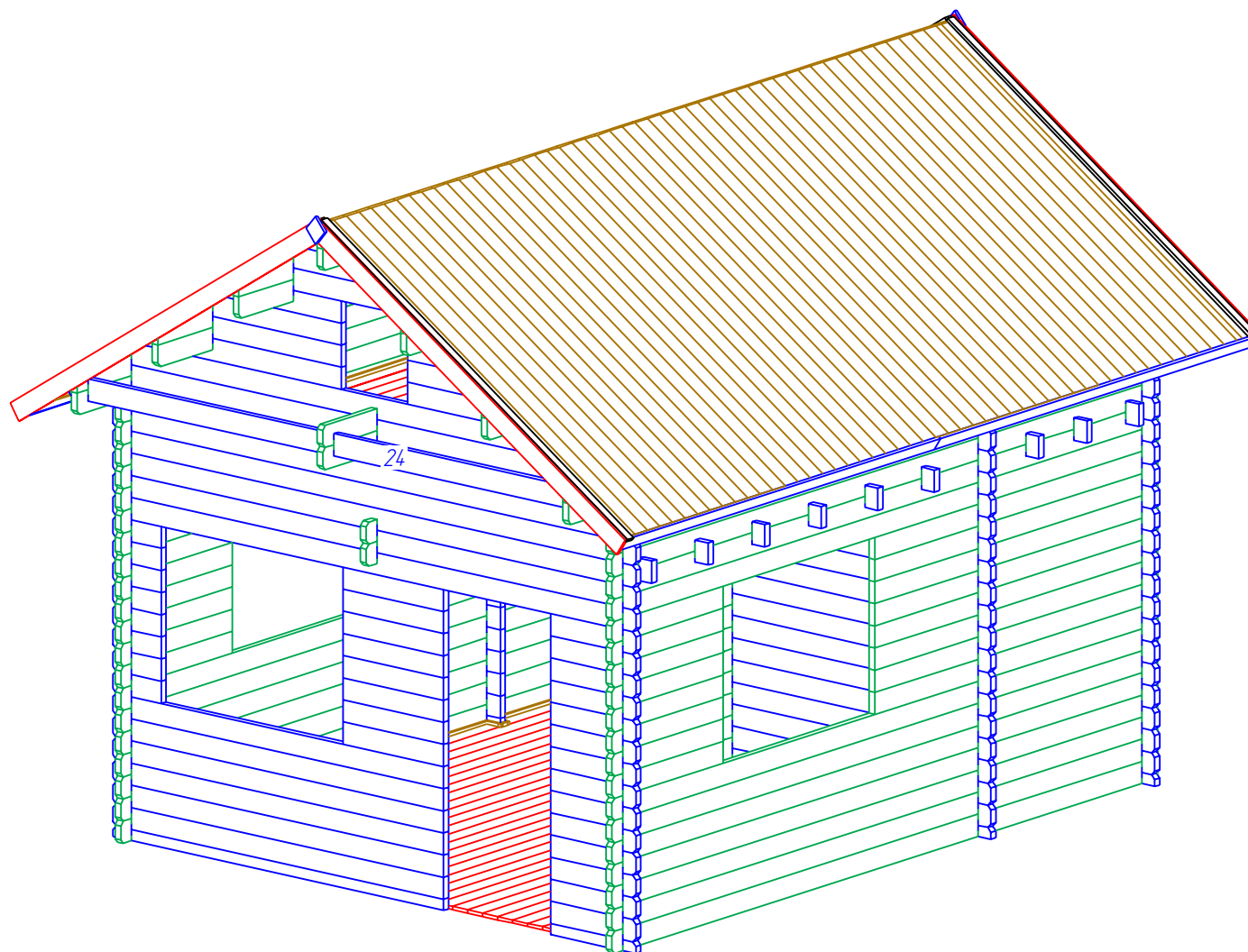

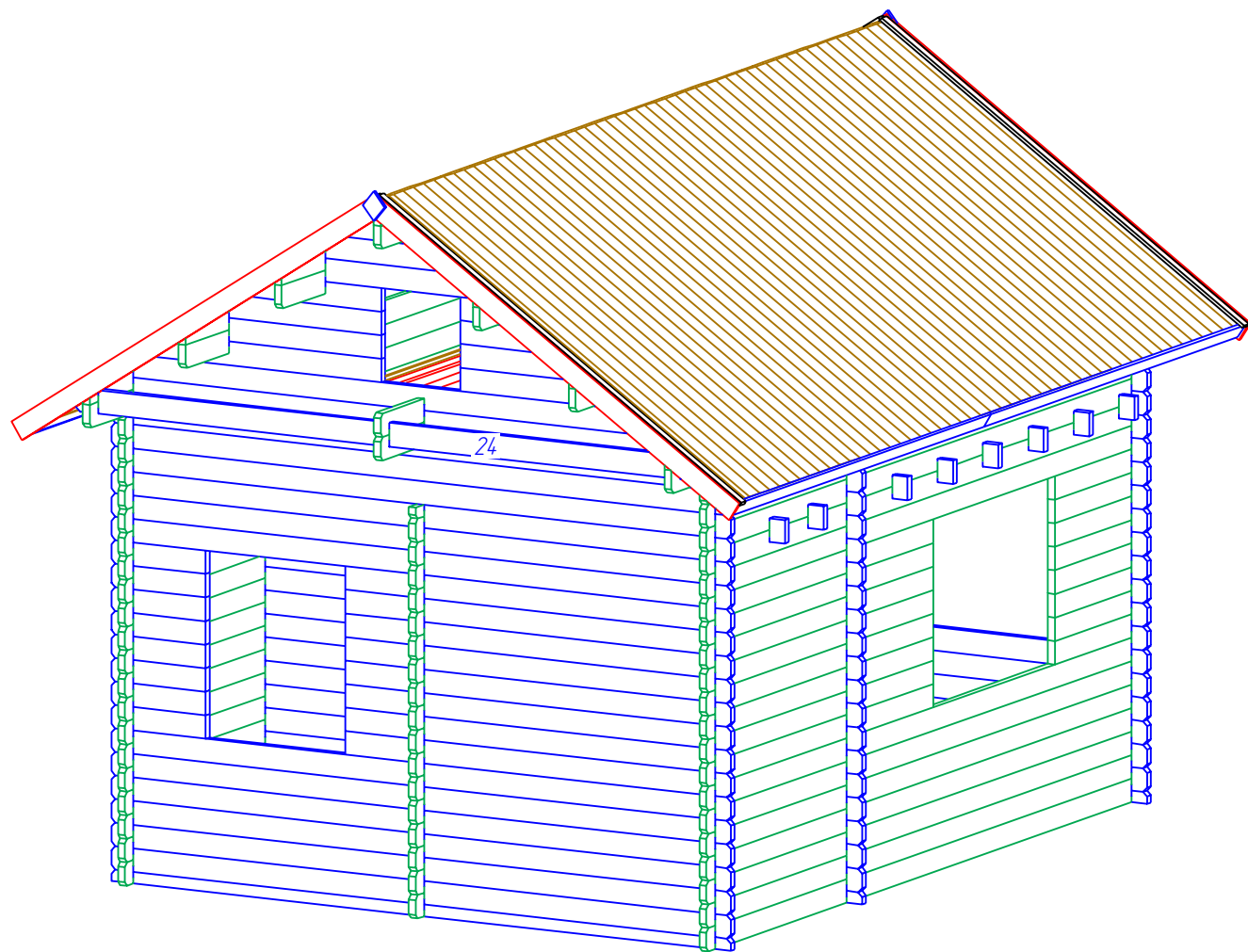

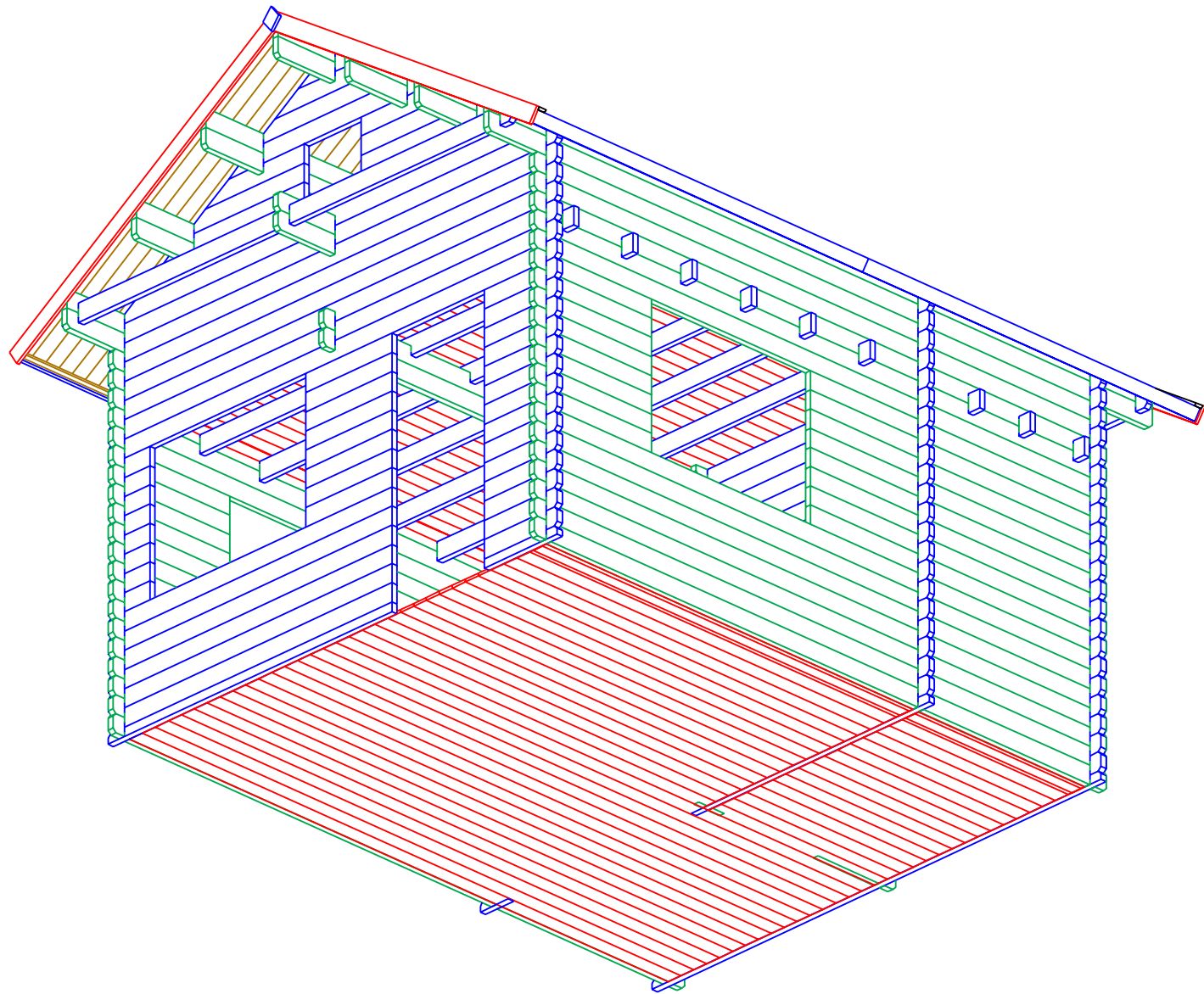

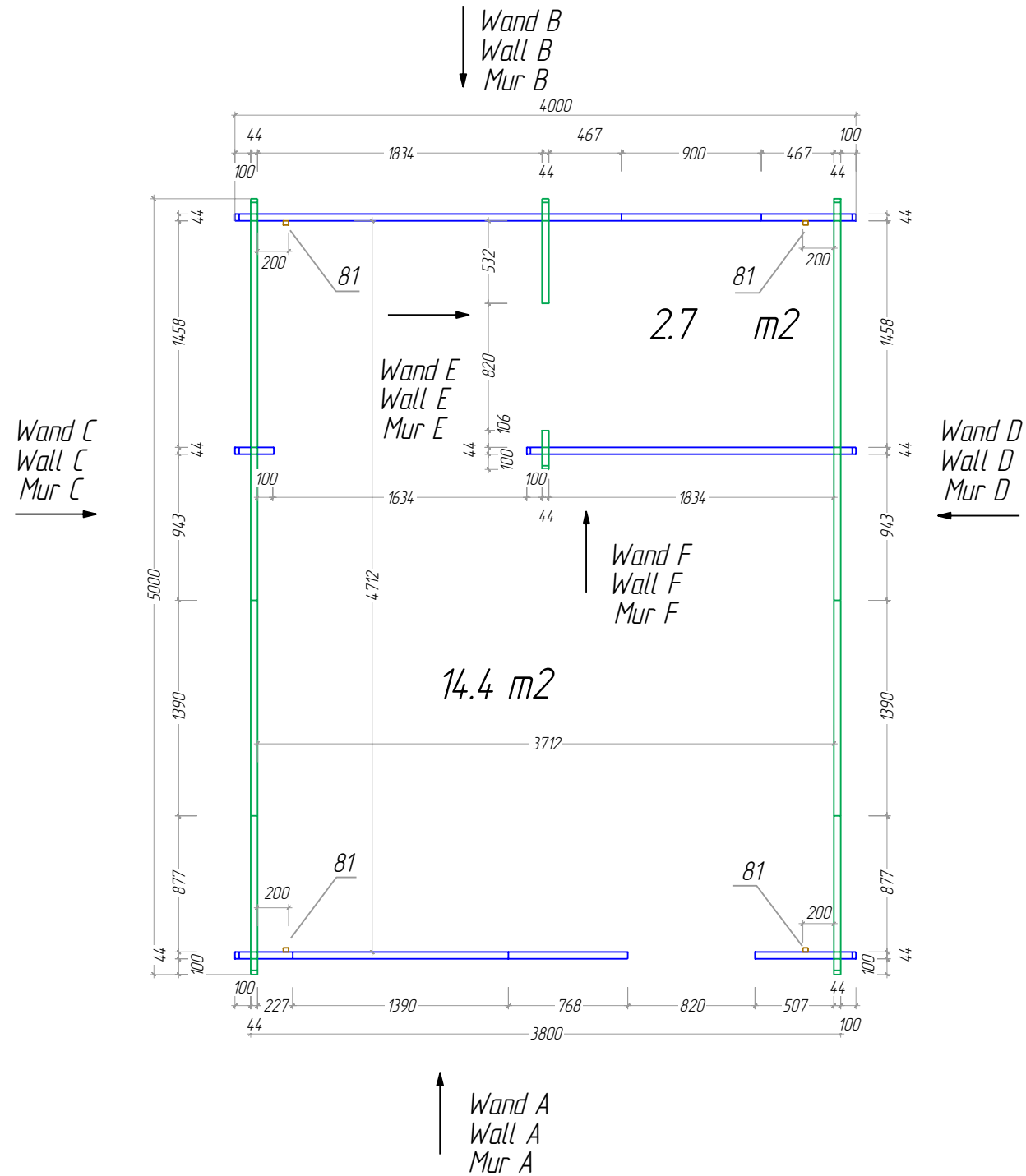

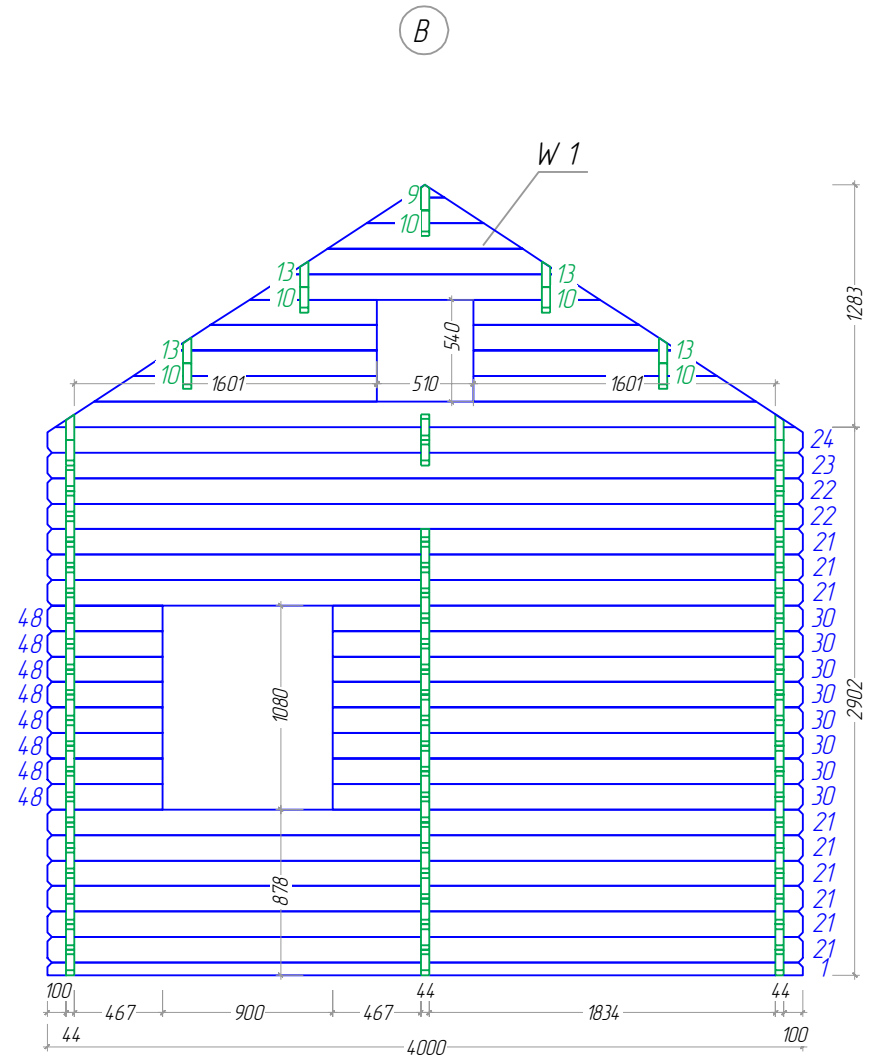
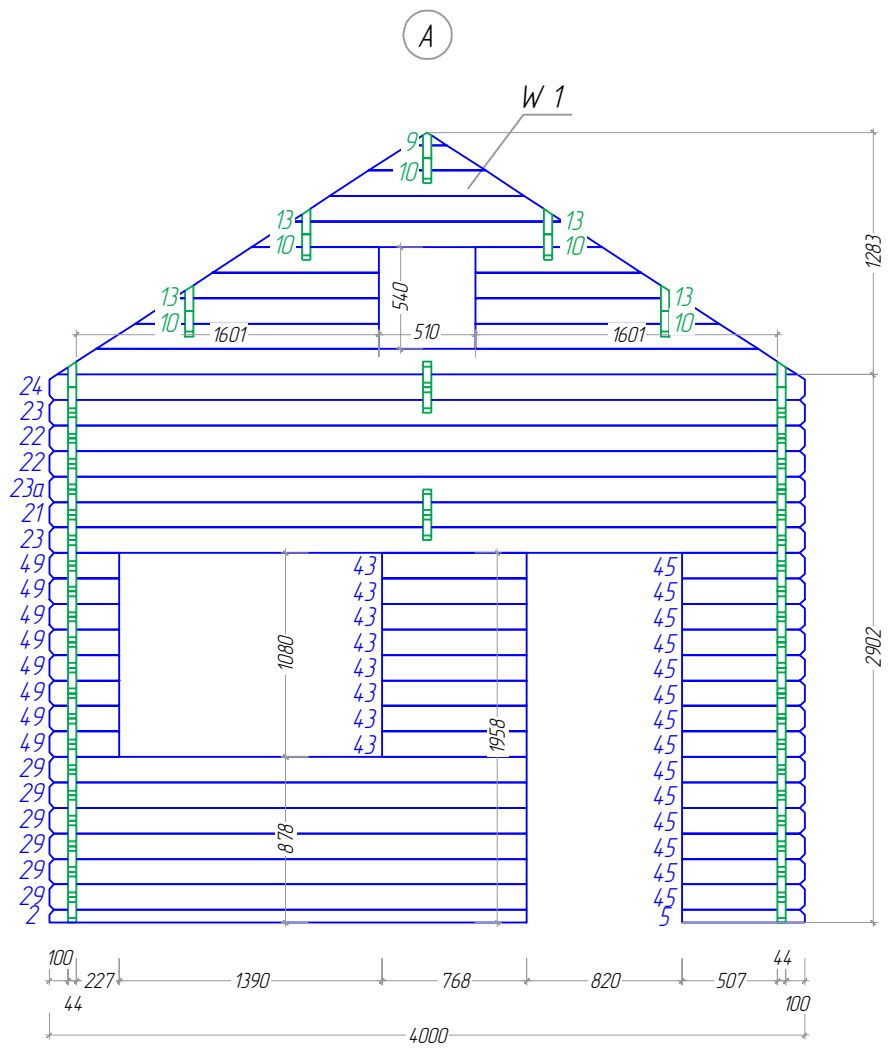

C

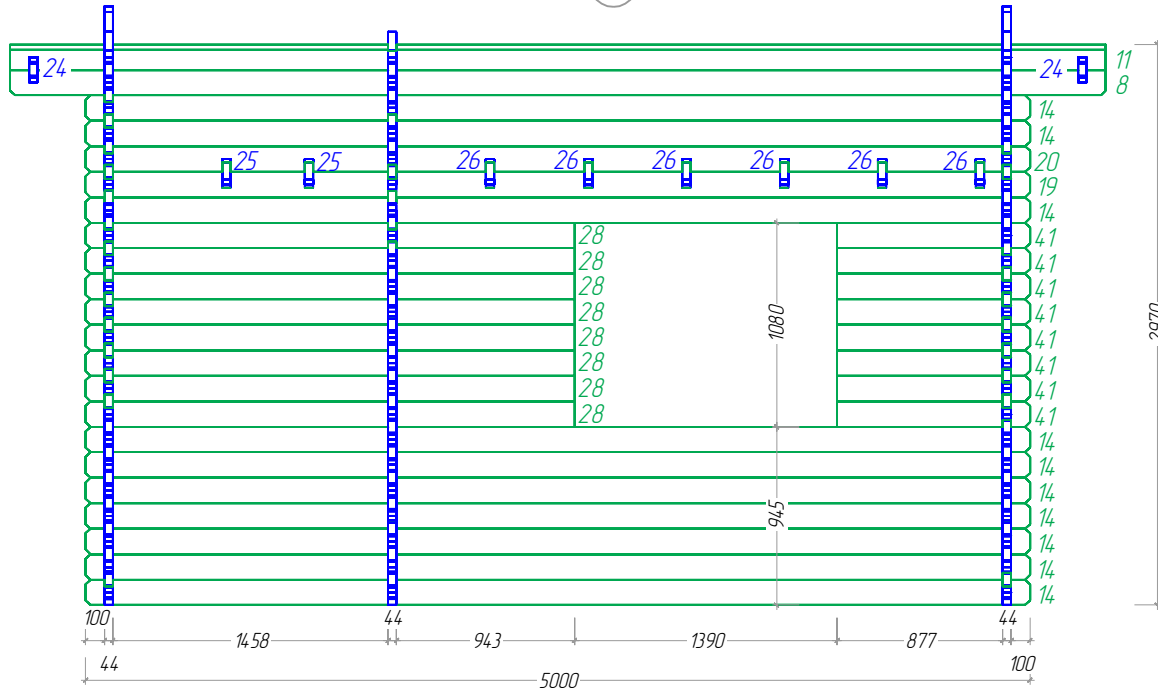

D

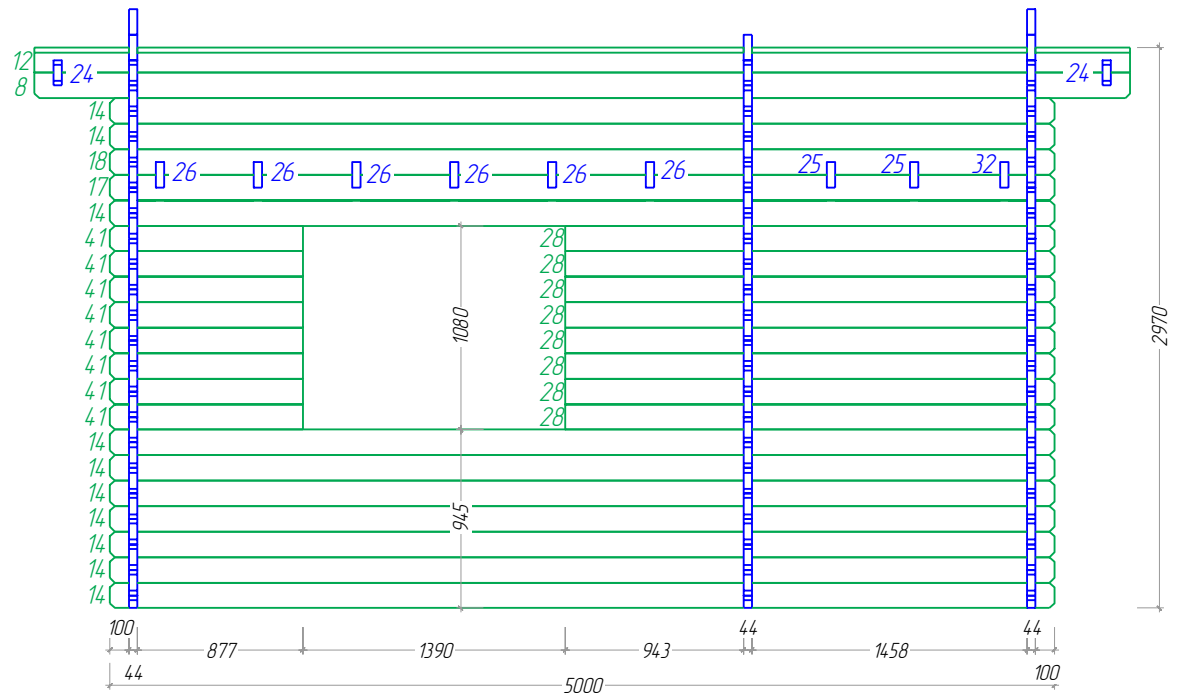

E

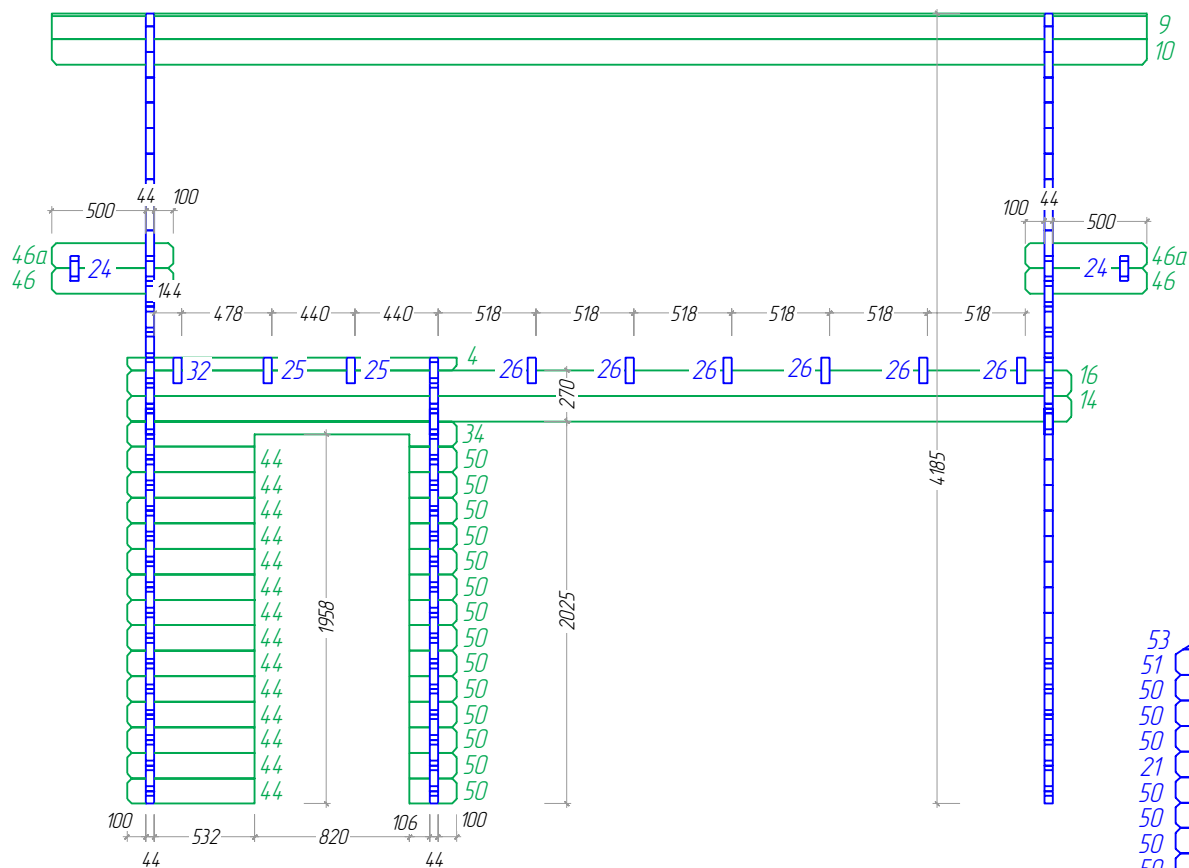

F

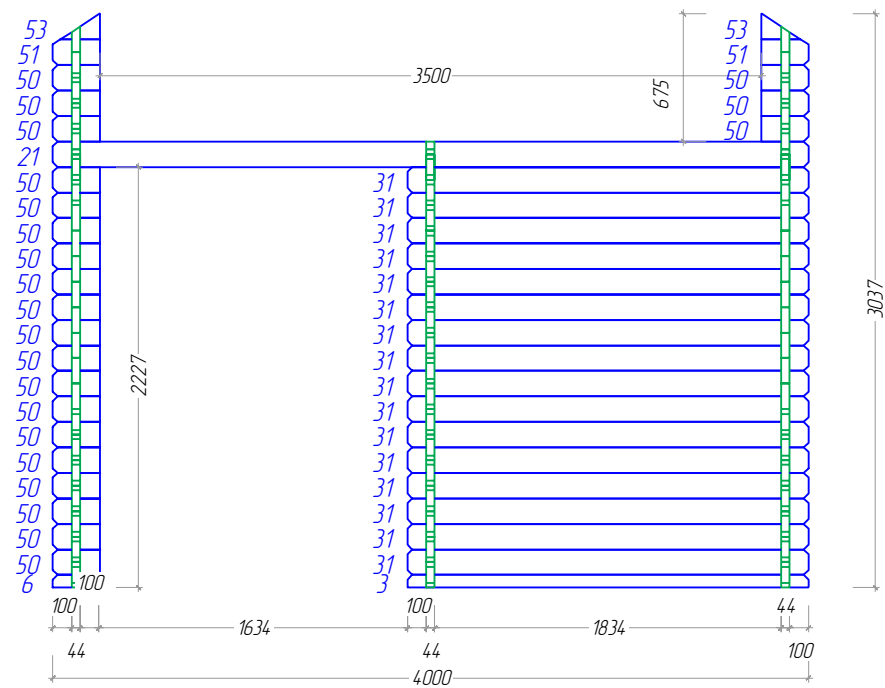

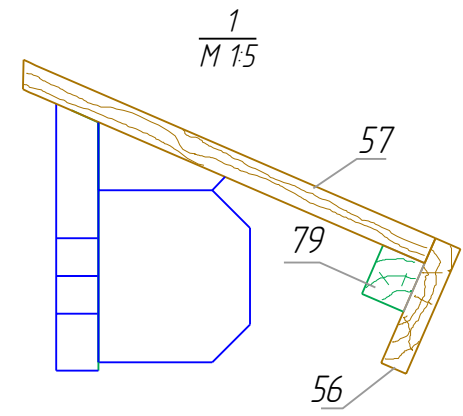
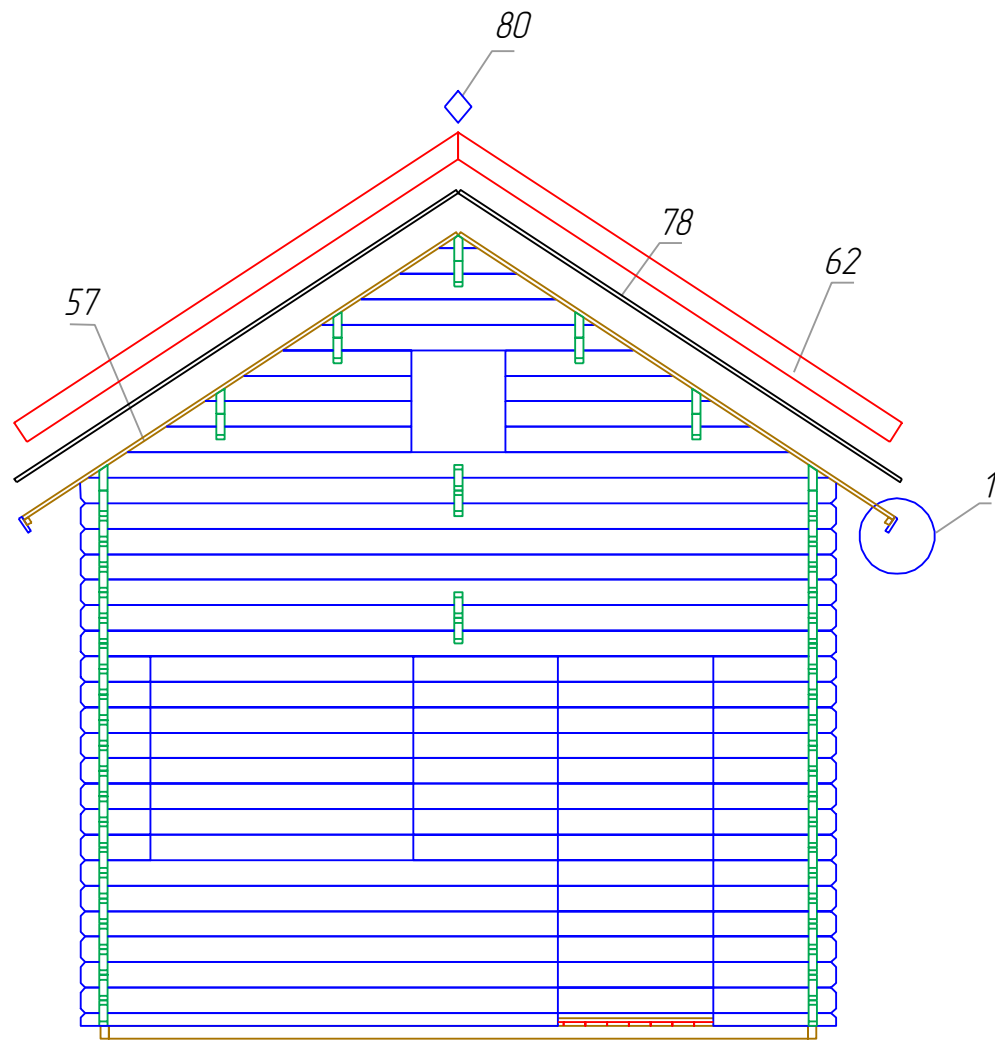

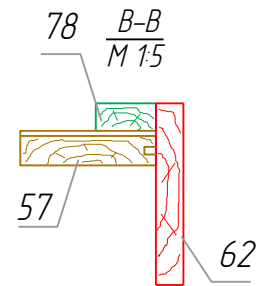
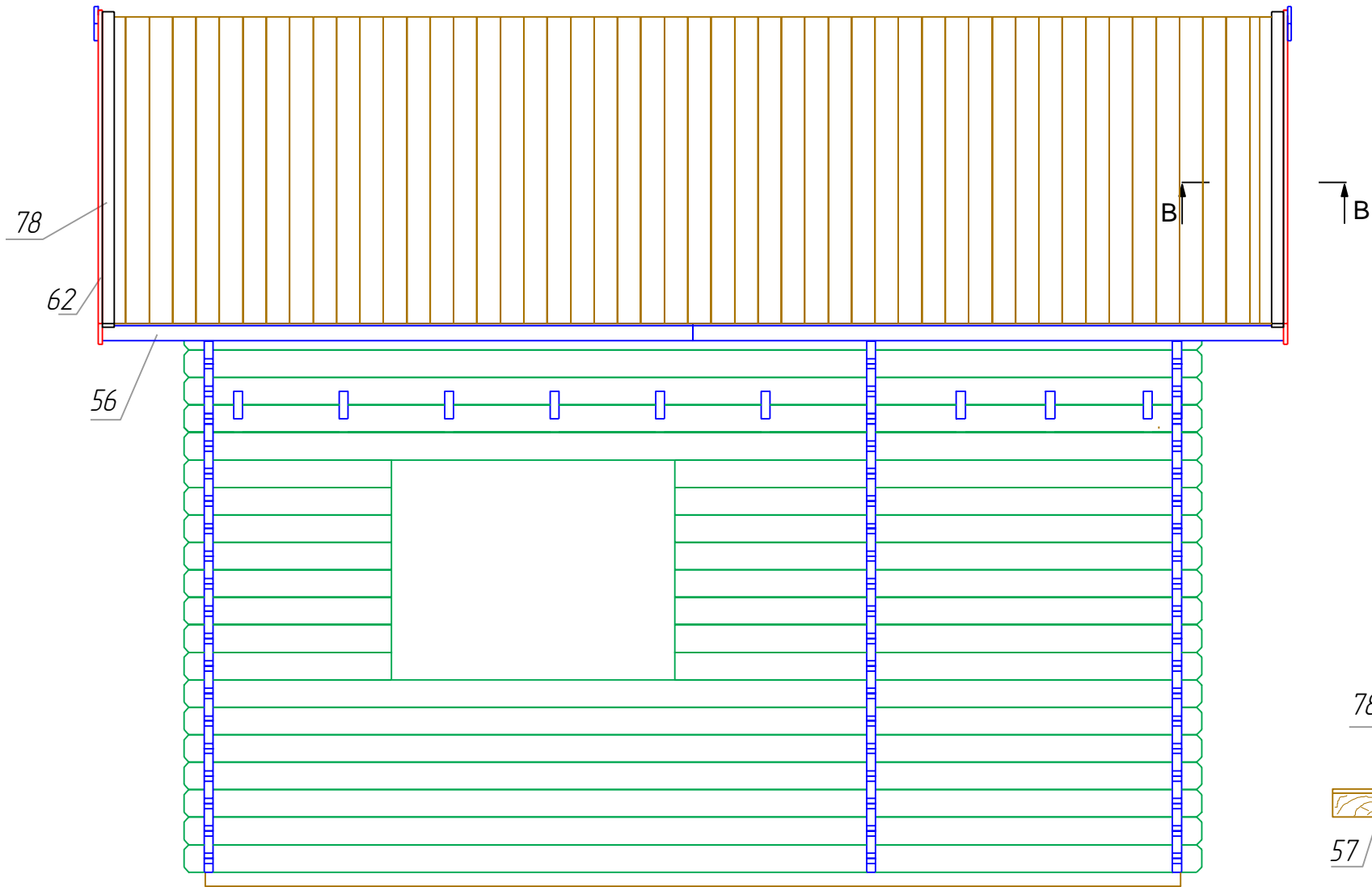

*Boarding joist plan
Trummplan
Lambourde plan*

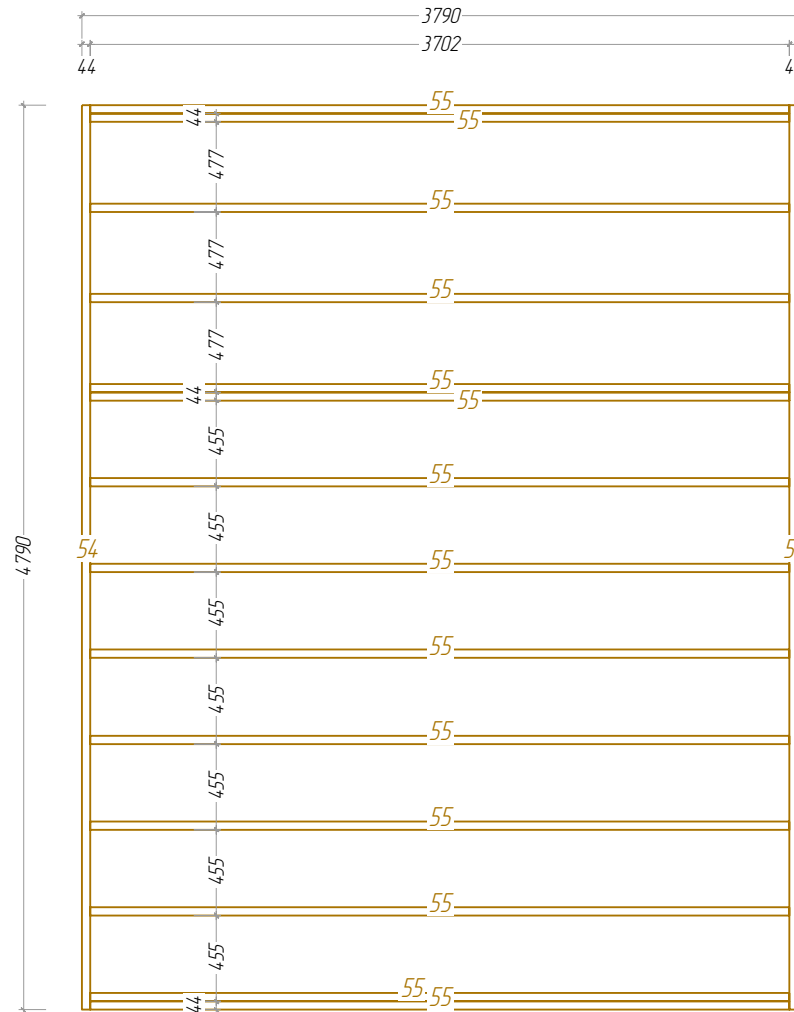

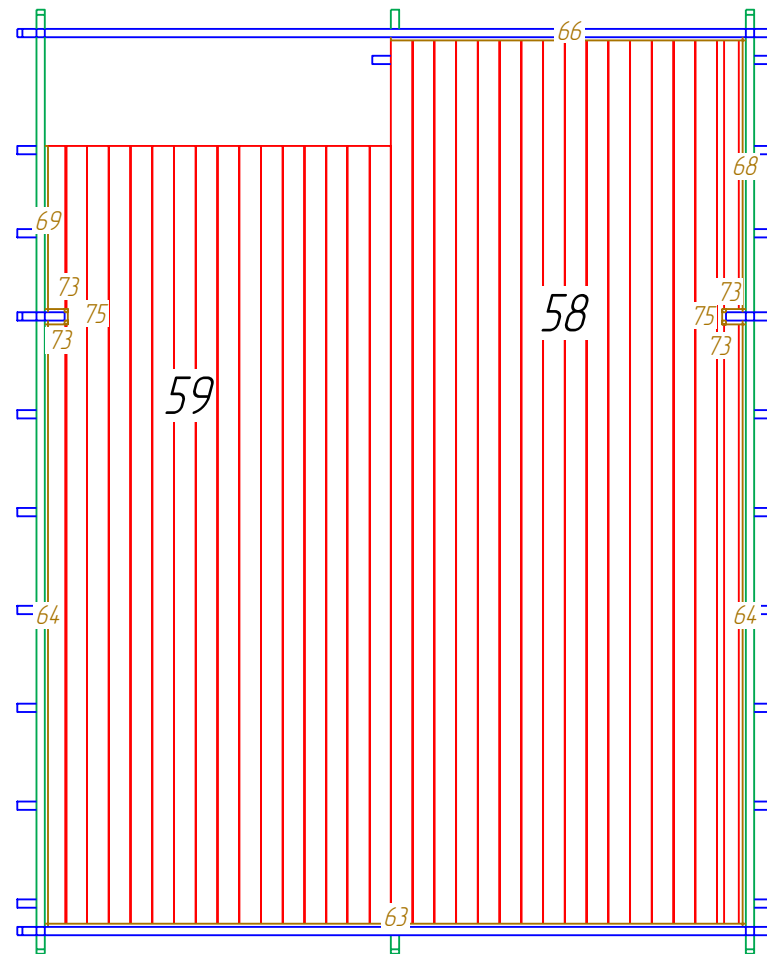
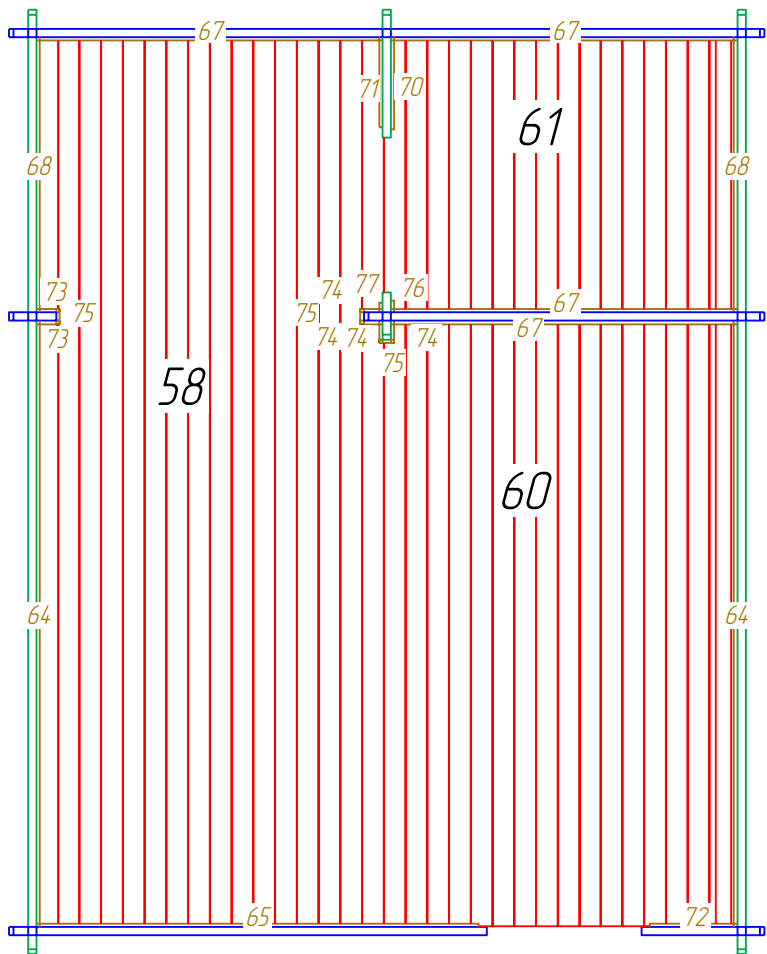







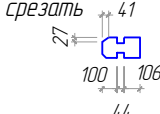
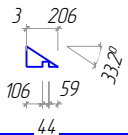







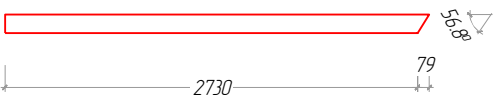







Nº	Orion 44 4x5	Nr.	Profile (mm)	Lenght (mm)
1		1	44x67,5	4000mm
2		1	44x67,5	2529mm
3		1	44x67,5	2122mm
4		1	44x67,5	1746mm
5		1	44x67,5	651mm
6		1	44x67,5	250mm
8		2	44x135	5800mm
9		1	44x135	5800mm
10		5	44x135	5800mm
11		1	44x135	5800mm
12		1	44x135	5800mm
13		4	44x135	5800mm
14		21+1	44x135	5000mm

№		Nr.	Profile (mm)	Length (mm)
16		1	44x135	5000mm
17		1	44x135	5000mm
18		1	44x135	5000mm
19		1	44x135	5000mm
20		1	44x135	5000mm
21		11	44x135	4000mm
22		4	44x135	4000mm
23		3	44x135	4000mm
23a		1	44x135	4000mm
24		4	44x135	4000mm
25		2	44x135	4000mm
26		6	44x135	4000mm
28		16	44x135	2589mm

Nº		Nr.	Profile (mm)	Lenght (mm)
29		6	44x135	2529mm
30		8	44x135	2489mm
31		16	44x135	2122mm
32		1	44x135	2122mm
34		1	44x135	1746mm
41		16	44x135	1021mm
43		8	44x135	768mm
44		14	44x135	676mm
45		14	44x135	651mm
46		2	44x135	644mm
46a		2	44x135	644mm
48		8	44x135	611mm
49		8	44x135	371mm

Nº		Nr.	Profile (mm)	Length (mm)
50		36	44x135	250mm
51		2	44x135	250mm
53		2	44x135	209mm
54	<i>Foundation</i> <i>Fundament</i> <i>Solive</i> 	2	44x68	4790mm
55	<i>Foundation</i> <i>Fundament</i> <i>Solive</i> 	14	44x68	3702mm
56	<i>Roof side boards</i> <i>Traufenbrett</i> <i>Planche de rive</i> 	4	18x90	2900mm
57	<i>Roof boards.</i> <i>Dachbretter</i> <i>Volige</i> 	102+1	20x115	2750mm
58	<i>Floor boards</i> <i>Fu ssboden</i> <i>Lame de plancher</i> 	33+2	20x115	4708mm
59	<i>Floor boards</i> <i>Fu ssboden</i> <i>Lame de plancher</i> 	16	20x115	4132mm
60	<i>Floor boards</i> <i>Fu ssboden</i> <i>Lame de plancher</i> 	17	20x115	3206mm
61	<i>Floor boards</i> <i>Fu ssboden</i> <i>Lame de plancher</i> 	17	20x115	1454mm
62	<i>Fascia board</i> <i>Giebelblende</i> <i>Planch de rive facade</i> 	4	20x120	2809mm
63	<i>Floor edge trim</i> <i>Fu bleisten</i> <i>Plinthe plancher</i> 	1	20x18	3712mm

Nº			Nr.	Profile (mm)	Lenght (mm)
64	Floor edge trim Fu bleisten Plinthe plancher		4	20x18	3210mm
65	Floor edge trim Fu bleisten Plinthe plancher		1	20x18	2342mm
66	Floor edge trim Fu bleisten Plinthe plancher		1	20x18	1878mm
67	Floor edge trim Fu bleisten Plinthe plancher		4	20x18	1834mm
68	Floor edge trim Fu bleisten Plinthe plancher		3	20x18	1458mm
69	Floor edge trim Fu bleisten Plinthe plancher		1	20x18	880mm
70	Floor edge trim Fu bleisten Plinthe plancher		1	20x18	489mm
71	Floor edge trim Fu bleisten Plinthe plancher		1	20x18	479mm
72	Floor edge trim Fu bleisten Plinthe plancher		1	20x18	464mm
73	Floor edge trim Fu bleisten Plinthe plancher		6	20x18	124mm
74	Floor edge trim Fu bleisten Plinthe plancher		4	20x18	118mm
75	Floor edge trim Fu bleisten Plinthe plancher		5	20x18	80mm
76	Floor edge trim Fu bleisten Plinthe plancher		1	20x18	63mm

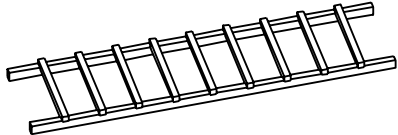
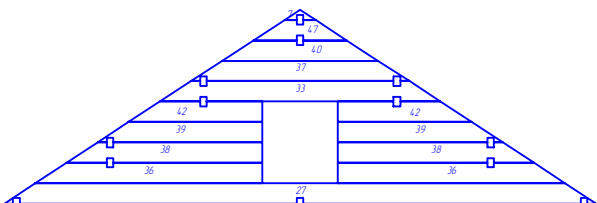
N°		Nr.	Profile (mm)	Lenght (mm)
77	Floor edge trim Fu bleisten Plinthe plancher	1	20x18	53mm
78	Roofing felt fillet Giebelabschlussbrett Latte de finition couverture	4	20x58	2796mm
79	Roof edge reinforcement Traufenleiste Tasseau	4	28x34	2900mm
80	Diamond Route Diamant	2	20x120	120mm
81	Storm protection	4	28x34	1900mm
Door Tur La porte	820 x 1958 MM	2		
Window Fenetre Fenster	900 x 1080 MM	1		
Window Fenetre Fenster	1390 x 1080 MM	3		
Window Fenetre Fenster	510 x 540 MM	2		
		1		
W1		2		

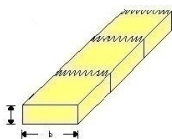

Les planches n8, n9, n10, n11, n12, n13 sont jointes par entures multiples afin de garantir la stabilité de la construction

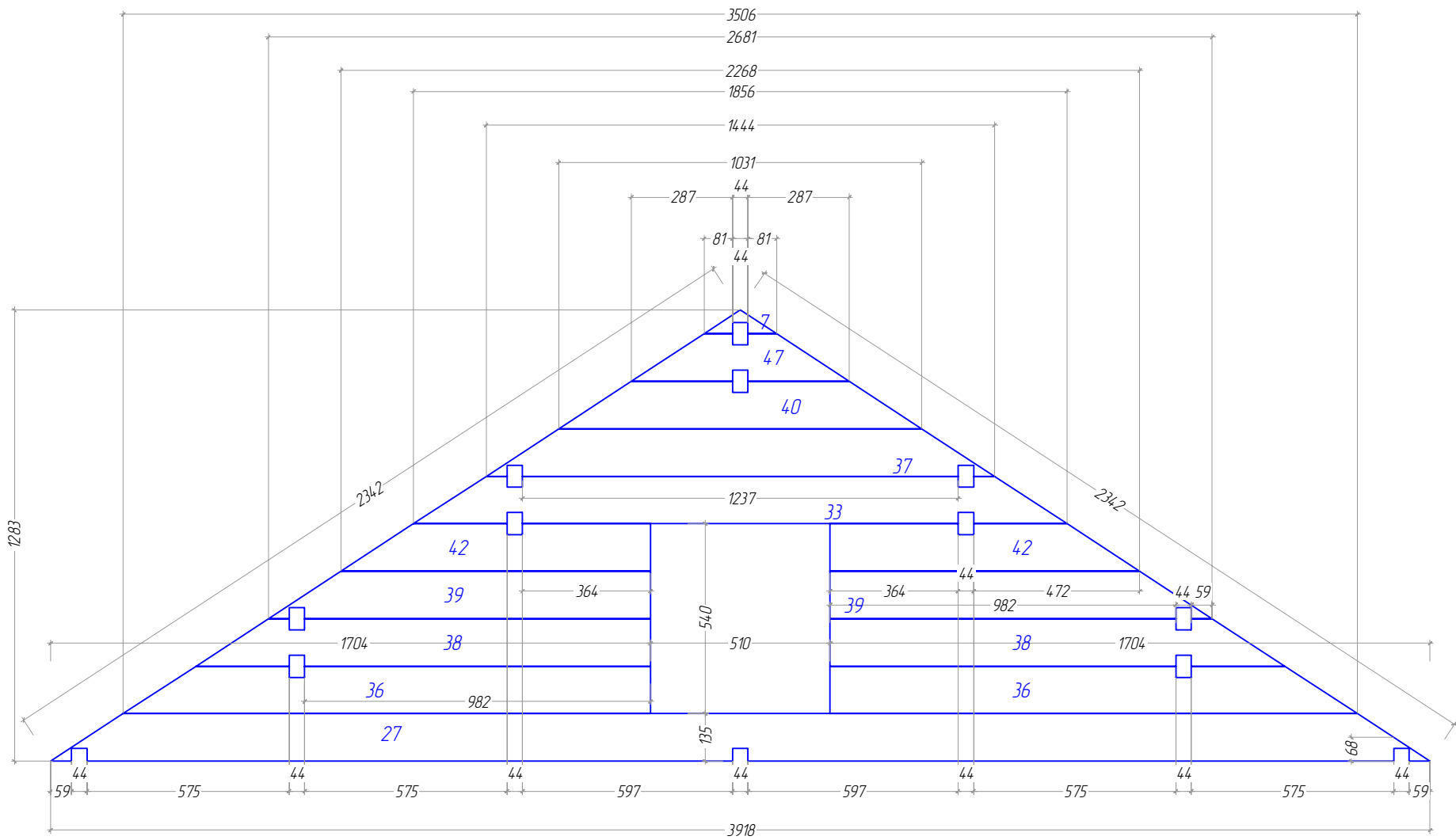

Storm protection

